



INSTALLATION MANUAL

MODEL #201193
50 AMP MANUAL TRANSFER SWITCH



ACTIVATE YOUR WARRANTY

by registering your product:
championpowerequipment.com

SERIAL NO.



Intertek



 **1-877-338-0999**

or visit championpowerequipment.com

READ AND SAVE THIS MANUAL. This manual contains important safety precautions which should be read and understood before operating the product. Failure to do so could result in serious injury. This manual should remain with the product.

Specifications, descriptions and illustrations in this manual are as accurate as known at the time of publication, but are subject to change without notice.

TABLE OF CONTENTS

Introduction	3	Operation	17
Safety Definitions	3	Drawing and Diagram	18
Important Safety Instructions	4	Dimensions Drawing	18
Instructions for Champion Manual Transfer Switch (MTS)	4	System Wiring Diagram	19
Before Installation	4	Specifications	20
Safety Labels	5	Technical Specifications	20
Safety Symbols	6	Warranty	20
Controls and Features	7		
Manual Transfer Switch	7		
Parts Included	8		
Parts Needed	8		
Equipment Description	9		
Installation	9		
Unpacking	9		
Location and Mounting Transfer Switch	9		
Utility Line Voltage Wiring	10		
Branch Circuit Wiring (USA Installation)	11		
Branch Circuit Wiring (Canada Installation)	11		
Circuit Breakers	13		
Power Inlet Box	14		
Installing and Wiring Power Inlet Box	14		
Wiring Power Inlet Box to Manual Transfer Switch	14		
Operation Check	15		

 FOR PARTS BREAKDOWN

Search by model number at
championpowerequipment.com

INTRODUCTION

Congratulations on your purchase of a Champion Power Equipment (CPE) product. CPE designs, builds, and supports all of our products to strict specifications and guidelines. With proper product knowledge, safe use, and regular maintenance, this product should bring years of satisfying service.

Every effort has been made to ensure the accuracy and completeness of the information in this manual at the time of publication, and we reserve the right to change, alter and/or improve the product and this document at any time without prior notice.

CPE highly values how our products are designed, manufactured, operated, and serviced as well as providing safety to the operator. Therefore, it is **IMPORTANT** to review this product manual and other product materials thoroughly and be fully aware and knowledgeable of the assembly, operation, dangers and maintenance of the product before use. Fully familiarize yourself, and make sure others who plan on operating the product fully familiarize themselves too, with the proper safety and operation procedures before each use. Please always exercise common sense and always err on the side of caution when operating the product to ensure no accident, property damage, or injury occurs. We want you to continue to use and be satisfied with your CPE product for years to come.

When contacting CPE about parts and/or service, you will need to supply the complete model and serial numbers of your product. Transcribe the information found on your product's nameplate label to the table below.

CPE TECHNICAL SUPPORT TEAM
1-877-338-0999
MODEL NUMBER
201193
SERIAL NUMBER
DATE OF PURCHASE
PURCHASE LOCATION

SAFETY DEFINITIONS

The purpose of safety symbols is to attract your attention to possible dangers. The safety symbols, and their explanations, deserve your careful attention and understanding. The safety warnings do not by themselves eliminate any danger. The instructions or warnings they give are not substitutes for proper accident prevention measures.

DANGER

DANGER indicates a hazardous situation which, if not avoided, will result in death or serious injury.

WARNING

WARNING indicates a hazardous situation which, if not avoided, could result in death or serious injury.

CAUTION

CAUTION indicates a hazardous situation which, if not avoided, could result in minor or moderate injury.

NOTICE

NOTICE indicates information considered important, but not hazard-related (e.g., messages relating to property damage).

IMPORTANT SAFETY INSTRUCTIONS

⚠ WARNING

Cancer and Reproductive Harm - www.P65Warnings.ca.gov

Instructions for Champion Manual Transfer Switch (MTS)

This manual has been prepared for familiarizing dealer/installer with the design, application, installation and servicing of the equipment.

Read the manual carefully and comply with all instructions.

It is recommended that a licensed electrician or an individual with complete knowledge of electricity perform the installation of the transfer switch.

This manual or a copy of this manual should remain with the transfer switch. Every effort has been taken to make sure that the contents of this manual are accurate and current.

The manufacturer reserves the right to change, alter or otherwise improve this manual and the product at any time without prior notice and without any obligation or liability whatsoever.

The manufacturer cannot anticipate every possible circumstance that might involve a hazard.

The warnings in this manual, tags and decals affixed to the unit are, therefore, not all-inclusive. If using a procedure, work method or operating technique the manufacturer does not specifically recommend, be sure to always follow all local municipal, state and national electrical codes to ensure safety for personnel.

Many accidents are caused by failing to follow simple and fundamental rules, codes and precautions. Before installing, operating or servicing this equipment, read the SAFETY RULES carefully.

Standards/Codes that cover the safe use and installation of the MTS are NFPA 70, NFPA 70E, UL 1008 and UL 67. It is important to refer to the latest version of any standard/code to ensure correct and current information. All installations must comply with local municipal, state and national codes.

Before Installation

⚠ WARNING

Per OSHA 3120 Publication; "lockout/tagout" refers to specific practices and procedures to safeguard individuals from the unexpected energization or startup of machinery and equipment, or the release of hazardous energy during installation, service or maintenance activities.

⚠ DANGER

Be certain that the power from the utility is turned off and all backup sources are locked out before starting this procedure. Failure to do so could result in serious injury or death.

⚠ CAUTION

Consult with your Local municipal, State and National electrical codes for proper mandatory wiring methods.

Safety Labels



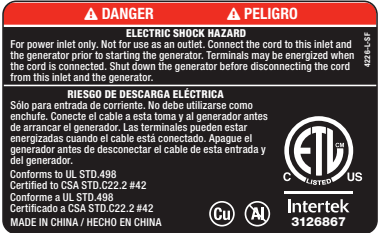

These labels warn you of potential hazards that can cause serious injury. Read them carefully.

If a label comes off or becomes hard to read, contact Technical Support Team for possible replacement.

	HANGTAG/LABEL	DESCRIPTION	PART NUMBER
1		<p>Danger. Electrocution shock hazard. Warning. More than one live circuit.</p>	<p>2458-L-PR</p>
2		<p>Danger. Electric shock hazard.</p>	<p>4226-L-SF</p>

Safety Symbols

Some of the following symbols may be used on this product. Please study them and learn their meaning. Proper interpretation of these symbols will allow you to more safely operate the product.

SYMBOL	MEANING
	<p>Ground. Consult with local electrician to determine grounding requirements before operation.</p>
	<p>Neutral. Neutral bus bar for all neutral wire connections.</p>
	<p>Utility. Indicates when there is power available from Utility or when transfer switch is in "UTILITY" mode.</p>
	<p>Generator. Indicates when there is power available from Generator or when transfer switch is in "GENERATOR" mode.</p>

CONTROLS AND FEATURES

Read this installation manual before installing your transfer switch. Familiarize yourself with the location and function of the controls and features. Save this manual for future reference.

Manual Transfer Switch

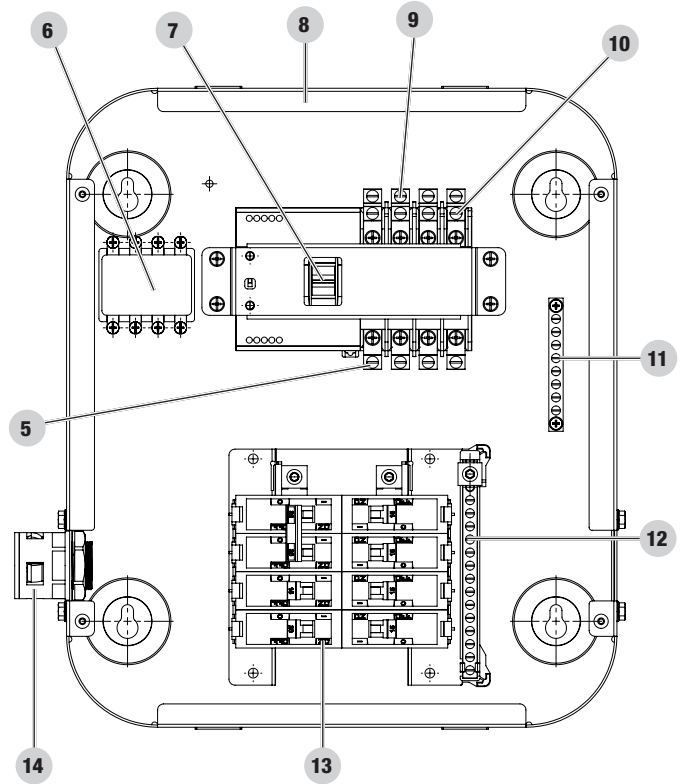
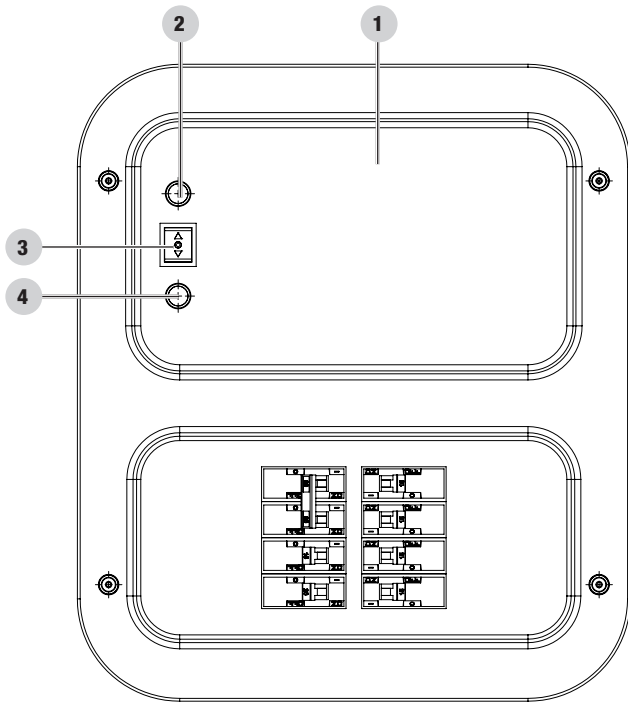

Cover Removed

- 1. Front Cover
- 2. Utility Green LED
- 3. Transfer Select Switch
- 4. Generator Blue LED
- 5. Load Terminals
- 6. Fuse Panel
- 7. 240V Transfer Switch

- 8. Enclosure
- 9. Utility Line Terminals
- 10. Generator Line Terminals
- 11. Ground Bus Bar
- 12. Neutral Bus Bar
- 13. Circuit Breaker Panel
- 14. Conduit Fitting

Parts Included

Pre-Wired Transfer Switch	1
Conduit Fitting	1
30 ft. (9.1 m) Power Cord	1
Power Inlet Box	1

Parts Needed

50A 2-Pole Circuit Breaker (compatible with type in main distribution panel)	1
NM-B Electrical Wire	(length as needed for installation)
Electrical Conduit	(length as needed for installation)
Conduit Fittings	(quantity as needed for installation)
Wire Connectors	(quantity as needed for installation)

EQUIPMENT DESCRIPTION

The Manual Transfer Switch (MTS) is used to transfer selected electrical circuits up to 50A from utility (grid) power source to generator power source. The transfer time is extremely fast causing almost no recognized break in service. The transfer switch prevents electrical feedback between the two power sources. The transfer switch is neutral switching providing compatibility with generators that are equipped with GFCI receptacles.

NOTICE

The MTS is ONLY compatible with generators that provide 240VAC output voltage. The MTS is not compatible with generators that only provide 120VAC output voltage.

INSTALLATION

Unpacking

1. Use care when unpacking to avoid damaging transfer switch components.
2. Allow the MTS to acclimate to room temperature for a minimum of 24 hours before unpacking to prevent condensation on the electrical apparatus.
3. Use a wet/dry vacuum cleaner or a dry cloth to remove dirt and packing material that may have accumulated in the transfer switch or any of its components during storage.
4. Do not use compressed air to clean the switch, cleaning with compressed air can cause debris to lodge in the components and damage the switch.
5. Retain the manual with or near the MTS for future reference.

Location and Mounting Transfer Switch

⚠ WARNING

DO NOT install outdoors. The MTS enclosure is rated for indoor installations only.

Although not required, it is recommended to install the MTS within 12 inches of the main distribution panel to utilize the included flexible conduit.

The MTS can be mounted on either side of the main distribution panel as the pre-wired flexible conduit can exit from either side of the enclosure.

To switch from factory assembled left side, unscrew cover plate on both left and right side, move pre-wired flexible conduit to other side, re-install cover plates on their appropriate side.

The MTS can be flush or surface mounted to the mounting surface but must be mounted vertical.

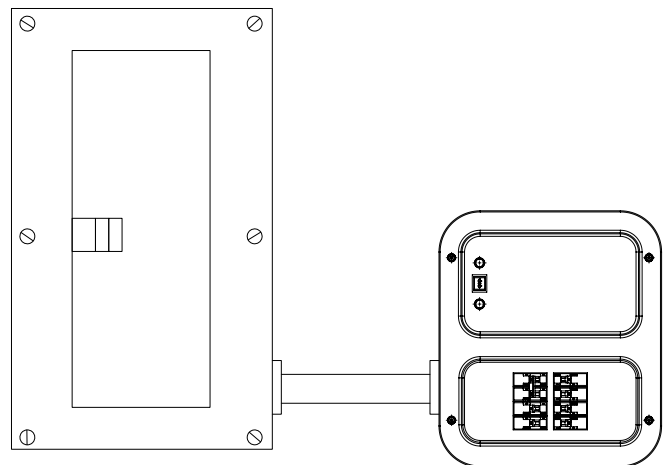

1. Remove front cover of MTS enclosure by removing (4) four screws and disconnecting the (3) three wiring harness connectors attached to the cover.
2. Position enclosure in desired location against mounting surface.
3. Using enclosure as a template, mark the four mounting hole locations. Mounting hole dimensions can also be found in the Drawings and Diagrams sections of this manual.
4. Set enclosure down.
5. At marked locations, drill appropriate hole size for mounting hardware being used.
6. Fasten MTS enclosure to mounting surface with appropriate hardware.

Utility Line Voltage Wiring

⚠ DANGER

It is recommended that a licensed electrician or an individual with complete knowledge of electricity perform the installation of the transfer switch.

Always be certain that the power from the main service panel is turned "OFF" and all backup sources are locked out prior to removal of the cover or removal of any wiring of the utility main service panel.

Even with the main circuit breaker switched off, the wires on the utility side of the main breaker are still live and contact with them can cause serious injury or death.

Failure to follow these instructions could result in serious injury or death.

⚠ CAUTION

Consult with your Local municipal, State and National electrical codes for proper mandatory wiring methods.

Installation and Wiring Diagrams can be found in the *Drawing and Diagrams* section of this manual.

1. Shut off main circuit breaker on main service panel.
2. Remove cover of main service panel.
3. Remove 1" knockout, drill 1-3/8" hole, or punch 1" conduit knockout (1.362") in the side of main service panel in-line with MTS flexible conduit outlet.
4. Install included flexible conduit fitting into the side of main service panel.
5. Pull pre-wired wire bundled through flexible conduit fitting into main service panel and insert flexible conduit into conduit fitting.
6. Install a compatible 50A, 2-pole circuit breaker (not included) in the main service panel. This will serve as the utility power source for the MTS.
7. Locate the GREEN grounding wire from the pre-wired bundle and connect to the grounding bus bar in main service panel.
8. Locate BLACK [MAIN 1-240V (L1)] and RED [MAIN 2-240V (L2)] wires from the pre-wired bundle and connect to the 50A circuit breaker added to main service panel.
9. Locate the WHITE [Neutral (N)] wire from the pre-wired bundle and connect to the neutral bus bar in main service panel.
10. Conductor Tightening Torque = 40 in-lbs.

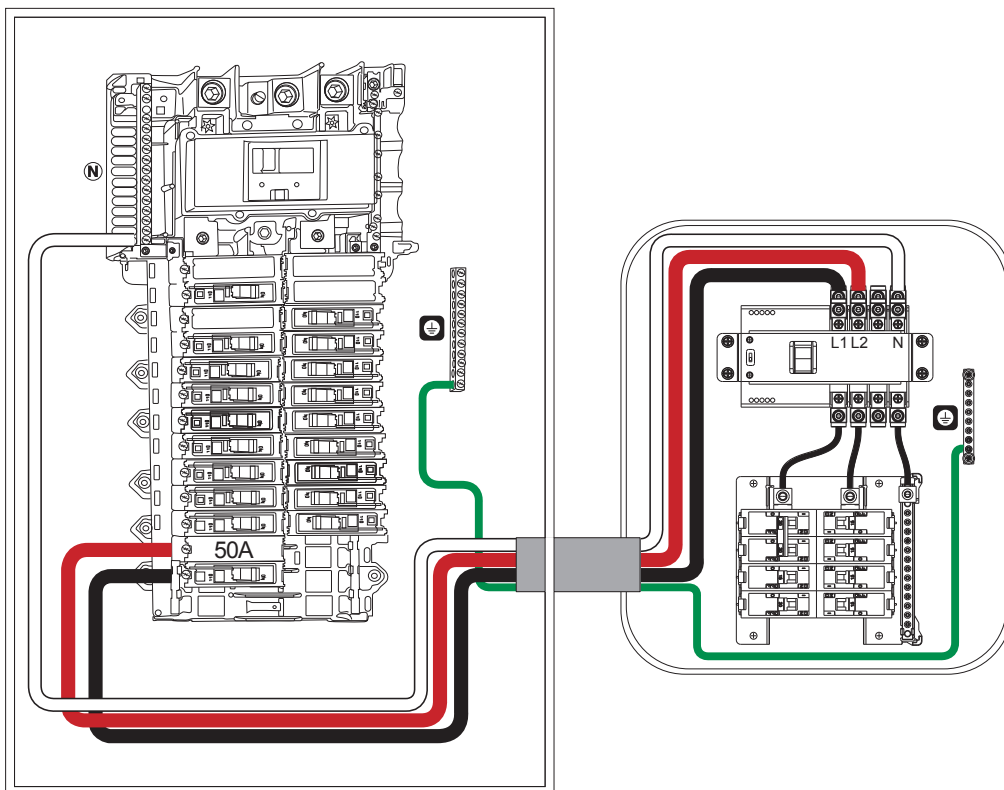

Branch Circuit Wiring (USA Installation)

⚠ WARNING

Rating of a transfer switch circuit breaker is not to exceed the rating of the corresponding branch circuit breaker in the main service panel.

1. From the main service panel, select a branch circuit to be powered by the generator during a power outage. When no power outage, selected circuits will be powered by utility.

NOTE: Multi-wire branch circuits must be connected to circuit breakers adjacent to each other. If the selected circuit to be powered by the generator is part of a multi-wire branch circuit, the entire multi-wire branch circuit must be relocated to the MTS. (Ref. NEC 210.4). Branch circuit wiring can be removed from the main service panel and installed in the MTS or spliced onto a new branch circuit originating from the MTS.

2. Turn off selected circuit breaker in main service panel.
3. Remove HOT wire from selected circuit breaker.
4. Remove NEUTRAL wire from bus bar of selected circuit.
5. From the MTS, select a branch circuit that is **LESS THAN or EQUAL TO** the circuit breaker ampacity of the selected circuit breaker in the main service panel. Locate that circuit breaker's colored wire from the pre-wired bundle and connect to the HOT wire removed from selected circuit breaker in main service panel with approved wire connector.
6. Locate that circuit's corresponding NEUTRAL wire from the pre-wired bundle and connect to the NEUTRAL wire removed from the selected circuit in main service panel with approved wire connector.

Circuit	Amp	Voltage	Color	AWG	Wire Marking
1	30	240	Black	10	30A-240V CIRCUIT1
2			Yellow	10	30A-240V CIRCUIT2
3	20	120	Brown	12	20A-120V CIRCUIT3
4	20	120	Orange	12	20A-120V CIRCUIT4
5	20	120	Red	12	20A-120V CIRCUIT5
6	30	240	Blue	10	30A-240V CIRCUIT6
7			Red	10	30A-240V CIRCUIT7
8	20	120	Black	12	20A-120V CIRCUIT8
9	20	120	Yellow	12	20A-120V CIRCUIT9
10	20	120	Pink	12	20A-120V CIRCUIT10

3	20	120	White	12	Neutral 3
4	20	120	White	12	Neutral 4
5	20	120	White	12	Neutral 5
8	20	120	White	12	Neutral 8
9	20	120	White	12	Neutral 9
10	20	120	White	12	Neutral 10

7. Label the branch circuit wire in the main service panel and the circuit breaker on MTS cover.
8. Repeat for each selected circuit.

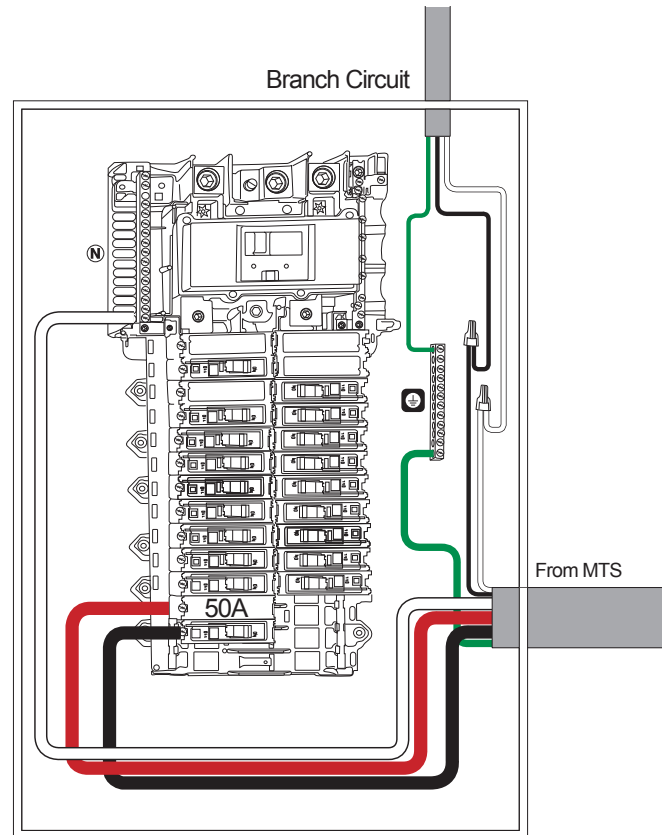

Branch Circuit Wiring (Canada Installation)

The Canadian Electric Code prohibits the use of the main service panel as a junction box. The selected branch circuits are to be connected to the MTS circuit wiring inside a proper junction box or directly connected to the circuit breakers inside the MTS.

Junction Box Connection Method

1. Mount proper junction box near main distribution panel so selected branch circuit wires can be routed and connected inside the junction box.
- NOTE: If required, size all conductors, raceways, conduits, and junction boxes to comply with applicable Canadian Electric Code (CEC) installation requirements for wire installation.
2. From the main service panel, select a branch circuit to be powered by the generator during a power outage. Note: When no power outage, selected circuits will be powered by utility.
 3. Turn off selected circuit breaker in main service panel.
 4. Remove HOT, NEUTRAL, and GROUND wire of the selected circuit.
 5. Pull cable out from main service panel and re-route to the junction box.

6. From the MTS, select a branch circuit that is **LESS THAN or EQUAL TO** the circuit breaker ampacity as selected circuit in the main service panel.
7. Locate that circuit breaker's colored wire from the pre-wired bundle and connect to the HOT wire from selected circuit in the junction box with appropriate wire connector.
8. Locate the NEUTRAL wire with the same circuit number as the HOT wire just pulled and connect to the NEUTRAL wire from the selected circuit in the junction box with appropriate wire connector.

NOTE: The pre-wired whip can be shortened or removed and replaced with field wiring. Follow all applicable CEC codes when field wiring is used.

11. Connect all GROUND wires in the junction box and route a single GROUND wire to the ground bus bar in the main service panel.

Circuit	Amp	Voltage	Color	AWG	Wire Marking
1	30	240	Black	10	30A-240V CIRCUIT1
2			Yellow	10	30A-240V CIRCUIT2
3	20	120	Brown	12	20A-120V CIRCUIT3
4	20	120	Orange	12	20A-120V CIRCUIT4
5	20	120	Red	12	20A-120V CIRCUIT5
6	30	240	Blue	10	30A-240V CIRCUIT6
7			Red	10	30A-240V CIRCUIT7
8	20	120	Black	12	20A-120V CIRCUIT8
9	20	120	Yellow	12	20A-120V CIRCUIT9
10	20	120	Pink	12	20A-120V CIRCUIT10

3	20	120	White	12	Neutral 3
4	20	120	White	12	Neutral 4
5	20	120	White	12	Neutral 5
8	20	120	White	12	Neutral 8
9	20	120	White	12	Neutral 9
10	20	120	White	12	Neutral 10

9. Label the branch circuit breaker on MTS cover.
10. Repeat for each selected circuit.

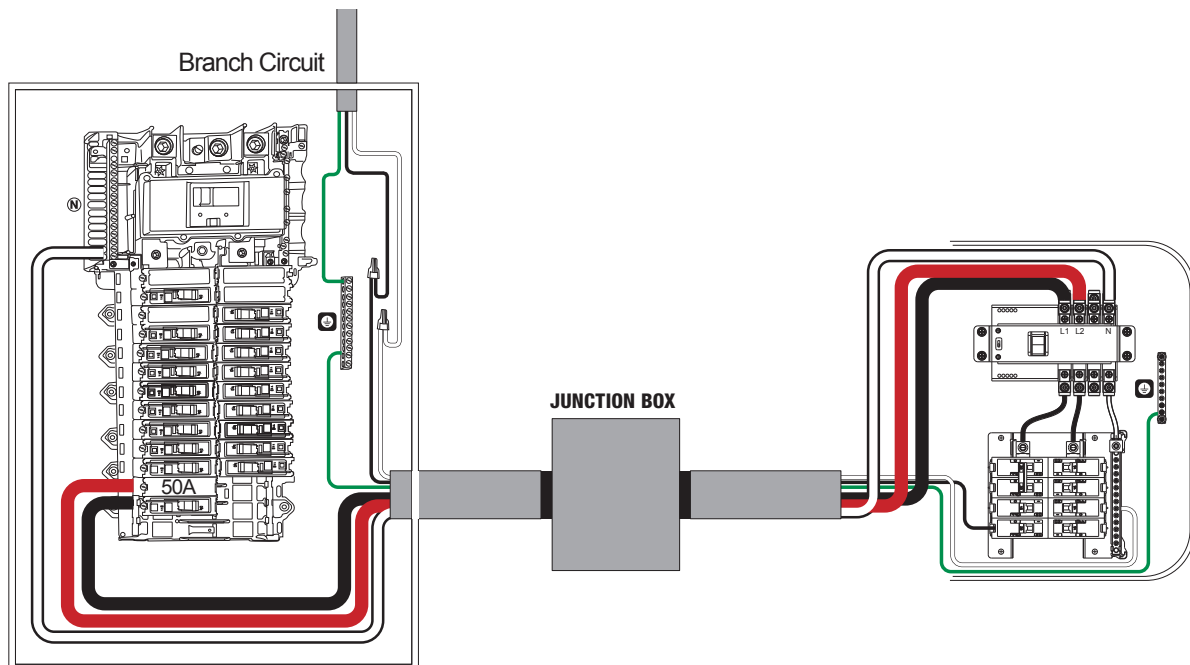

Direct Connect Method

1. From the main service panel, select a branch circuit to be powered by the generator during a power outage. Note: When no power outage, selected circuits will be powered by utility.

NOTE: If the selected circuit to be powered by the generator is part of a multi-wire branch circuit, the entire multi-wire branch circuit must be relocated to the MTS.

2. Turn off selected circuit breaker in main distribution panel.
3. Remove HOT, NEUTRAL, and GROUND wire of the selected circuit.
4. Re-route cable into the manual transfer switch enclosure.
5. If required, punch hole in MTS enclosure for conduit, fitting, or raceway and follow CEC installation requirements.
6. From the MTS, select a branch circuit that is **LESS THAN or EQUAL TO** the circuit in the main service panel.
7. Connect the HOT wire to the circuit breaker.
8. Connect the NEUTRAL wire to the neutral bus bar.
9. Connect the GROUND wire to the ground bus bar.
10. Label the branch circuit breaker on MTS cover.
11. Repeat for each selected circuit.

NOTE: The pre-wired whip can be shortened or removed and replaced with field wiring. Follow all applicable CEC codes when field wiring is used.

Circuit Breakers

Factory supplies a combination of 20A, and 30A circuit breakers. Locations of breakers can be changed in the field as needed. Single pole breakers can replace 2-pole breakers. 2-pole breakers can replace single pole breakers.

Circuit breakers included from the factory are not GFCI or AFCI type. Accepted use breakers are from the following manufactures:

- Siemens type QP
- Eaton type BR
- Square D type HOM

Follow all applicable NEC or CEC codes when making field modifications.

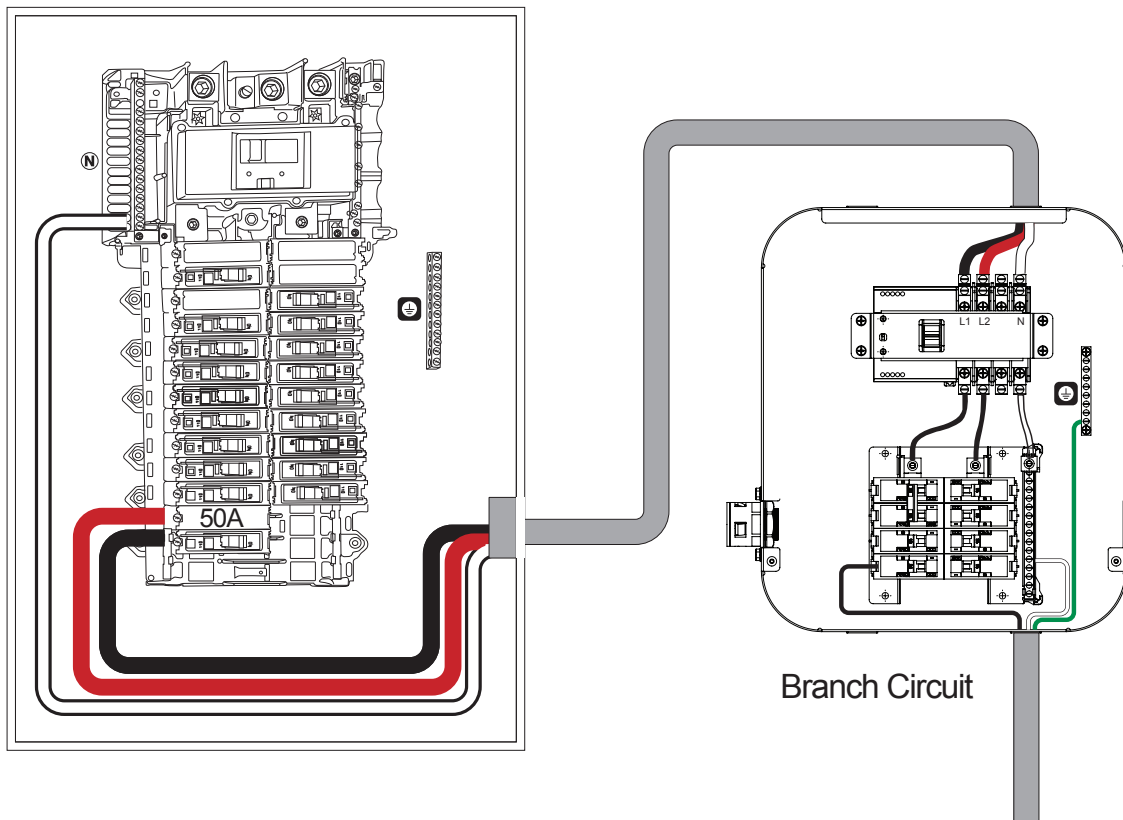

Power Inlet Box

Since a portable generator is operated outdoors, far away from occupied buildings, the included NEMA 3R outdoor rated Power Inlet Box (PIB) will be used to connect the generator to the MTS. The generator is connected to the PIB through the included 30 foot Power Cord. The PIB will be hardwired directly to the MTS. See *System Wiring Diagram* on page 17 for more information.

When the generator is providing power to the PIB with the Power Cord, the green LED indicator will be lit showing power to the PIB receptacle.

Installing and Wiring Power Inlet Box

Locate the PIB on an exterior wall that will ensure the generator will be as far away from windows, doors, and vents as possible.

⚠ CAUTION

Consult with your Local municipal, State and National electrical codes for proper mandatory wiring methods.

1. Loosen screw at the bottom front of the box and lift off the cover.
2. Determine which conduit hole location on the box will provide most convenient routing into the building and to the MTS.
3. Remove plastic plug and seal.

NOTE: In order to maintain NEMA 3R outdoor rating, use conduit fitting listed for use in wet locations.

4. Using the 3 holes provided on the back of the box, mount PIB on exterior wall.
5. Run cable/conduit from the PIB to the MTS allowing extra length on cable at both ends for wire connections.
6. Loosen screw on the grounding terminal inside the box. Cut green grounding wire of cable to final length and strip wire insulation. Making sure both green grounding wires from the PIB receptacle and cable are inserted in-between plates on the grounding terminal.
7. Cut red, black, and white wires of cable to final length and strip wire insulation.
8. On the back of the outlet, insert white wire into hole colored white (marked "W"), tighten corresponding screw. Insert red wire into hole colored red (marked "X"), tighten corresponding screw. Insert black wire into hole colored clear (marked "Y"), tighten corresponding screw.

NOTE: Tighten all screws to 35 inch-pounds torque.

9. Carefully fold wires into box, replace cover, and tighten bottom screw.

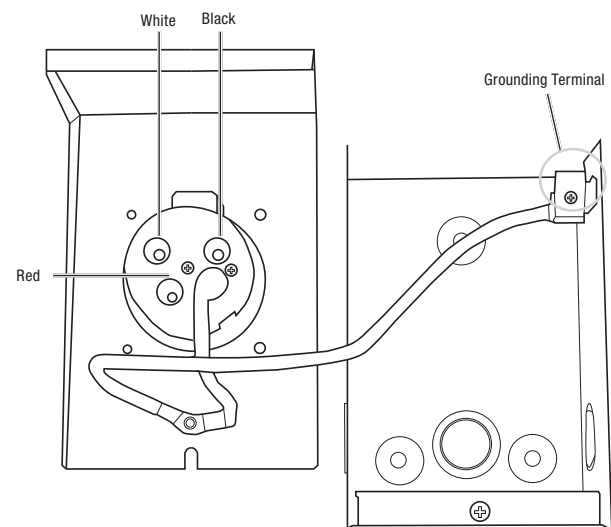

Wiring Power Inlet Box to Manual Transfer Switch

The MTS enclosure includes knockouts on top and bottom to connect cable/conduit from the Power Inlet Box or a hole can be drilled/punched at a location of the installers choice.

⚠ CAUTION

Consult with your Local municipal, State and National electrical codes for proper mandatory wiring methods.

1. Using one of the knockouts or drilled hole, following NEC or CEC codes, connect cable/conduit from the PIB to the MTS and pull enough cable into the inside of the MTS to reach the top terminals of the transfer switch and the grounding terminal for green grounding wire.
2. Cut red, black, white, and green wires of cable to final length and strip wire insulation.
3. Connect green ground wire to ground bus bar.
4. Connect black wire to L1 terminal on transfer switch.
5. Connect red wire to L2 terminal on transfer switch.
6. Connect white wire to N terminal on transfer switch.

7. Conductor Tightening Torque = 40 in-lbs.

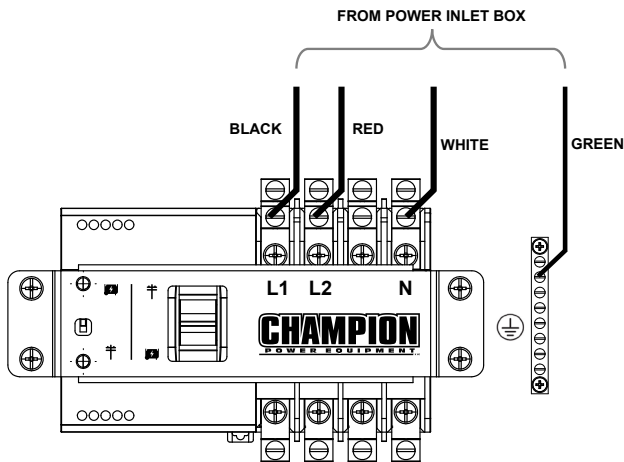

Utility Voltage:

1. Manually move transfer switch lever up to the "UTILITY" position.

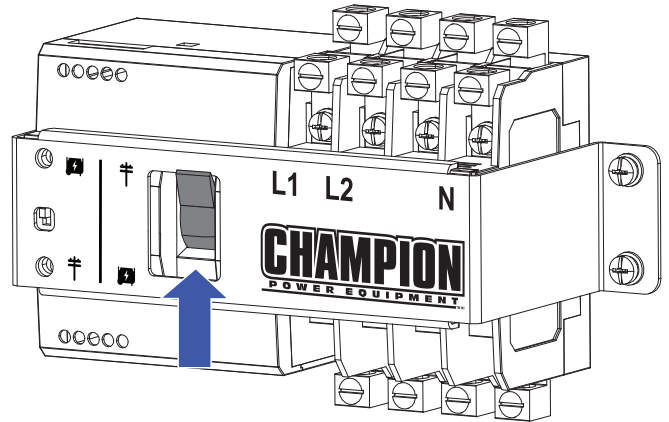

2. Turn on utility power to transfer switch by flipping main circuit breaker in main service panel as well as the 50A double pole breaker that was installed to the "ON" position.
3. Using the digital multimeter mentioned above, measure across the lower transfer switch terminals L1 and L2. The multimeter reading is to be approximately 240VAC.
4. Measure across the lower transfer switch terminals L1 and N. The multimeter reading is to be approximately 120VAC.
5. Measure across the lower transfer switch terminals L2 and N. The multimeter reading is to be approximately 120VAC.

If readings are not as specified, check that breakers are in the "ON" position in main distribution panel and all wire connections are tight.

6. Turn off utility power to transfer switch by flipping the main circuit breaker in main service panel to the "OFF" position.

Generator Voltage:

1. Manually move transfer switch lever down to the "GENERATOR" position.

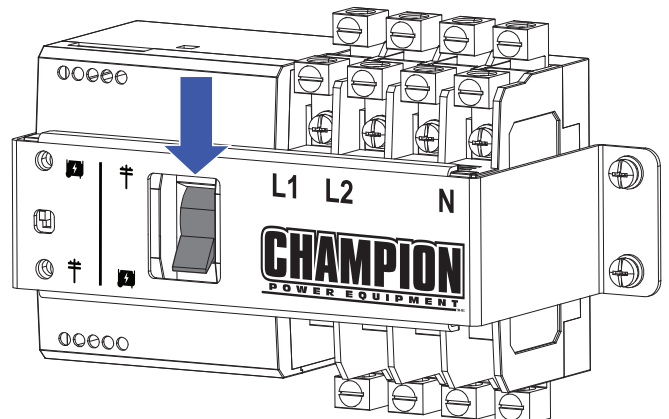

2. Setup generator outdoors, far away from occupied buildings and connect power cord to PIB.

Operation Check

NOTICE

A qualified electrician is to inspect the installation of the transfer switch and power inlet box BEFORE operation check is performed. The installation must comply with all applicable federal, state, and local codes.

For operation check, use a digital multimeter with low impedance setting (LoZ) to be able to collect accurate voltage readings. LoZ mode eliminates phantom or stray voltage readings.

DANGER

Be certain that the power from the utility and the generator are turned off before starting this procedure. Failure to do so could result in serious injury or death.

3. Start generator.
4. Using the digital multimeter mentioned above, measure across the lower transfer switch terminals L1 and L2. The multimeter reading is to be approximately 240VAC.
5. Measure across the lower transfer switch terminals L1 and N. The multimeter reading is to be approximately 120VAC.
6. Measure across the lower transfer switch terminals L2 and N. The multimeter reading is to be approximately 120VAC.

If readings are not as specified, confirm breaker on generator is on, the indicating light on the PIB is on, and all wire connections are tight.

7. Turn off generator.

Generator Under Load:

The purpose of this test is to understand how the generator operates under the load of the circuits that have been selected to be backed up.

1. Turn off utility power to transfer switch by flipping main circuit breaker in main service panel to the "OFF" position.
2. Manually move transfer switch lever down to the "GENERATOR" position.

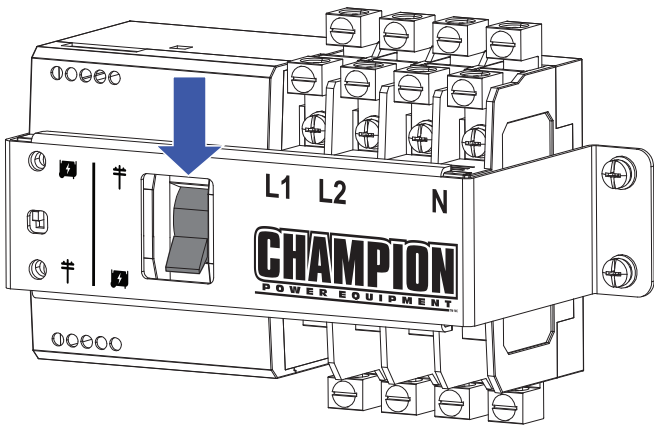

3. Turn off all circuit breakers on MTS.
4. Setup generator outdoors, far away from occupied buildings and connect power cord to PIB.
5. Start generator. Generator is now powering all selected circuits.
6. Turn on a selected circuit breaker and then apply load to that circuit. For example, if one of the selected circuits is a well pump, turn on the well pump.
7. Continue to turn on selected circuits up to the rating of the generator. DO NOT overload the generator. Depending on the size of generator and load of the selected circuits, generator may only be able to power a single circuit or multiple circuits at one time.
8. Once an understanding of which circuits can be run with the generator, turn on all circuit breakers on MTS.

9. Let generator run at no load for several minutes then turn off generator.
10. Manually move transfer switch lever up to the "UTILITY" position.

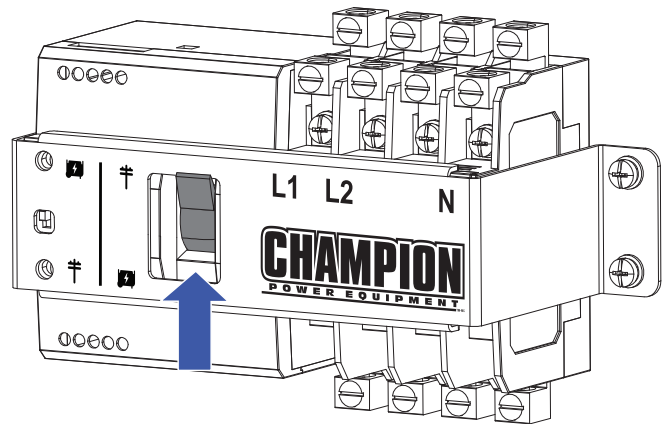

Completing Installation



1. Verify installation has been properly performed and signed-off by qualified electrician to meet all federal, state, and local codes.
2. Verify system works properly through Operation Check procedure.
3. Manually move transfer switch lever up to the "UTILITY" position if not already there.
4. Connect three wiring connectors from cover to transfer switch wire harness.
5. Install cover on MTS and secure with four screws provided.
6. Turn on all circuit breakers on MTS.
7. Install cover on main service panel.
8. Turn on all circuit breakers on main service panel including main circuit breaker.

All circuits in the house should be on. The green light on the MTS front panel should be on. This indicates select circuits in MTS are being powered by Utility.

The Champion Manual Transfer Switch is now ready for use.

OPERATION

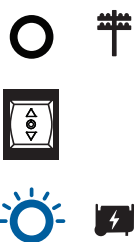
The green and blue lights on front panel indicate where power is available from; Utility, Generator, or both.

Green light illuminated indicates power present at transfer switch from Utility.	Blue light illuminated indicates power present at transfer switch from Generator.	Both lights illuminated indicated power present at transfer switch from Utility to Generator.
		

The rocker switch on front panel transfers power to the selected circuits from either Utility or Generator.

Push top of switch to transfer to Utility power source.
Push bottom of switch to transfer to Generator power source.

NOTE: The switch will not operate in the direction of Utility or Generator until that power source's light is illuminated.

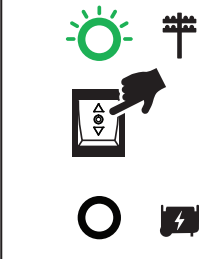
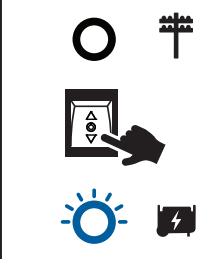
Push top of switch to transfer to Utility power source.	Push bottom of switch to transfer to Generator power source.
	

Transferring from Utility to Generator

⚠ DANGER

Generator exhaust contains carbon monoxide, a colorless, odorless, poisonous gas. Breathing carbon monoxide will cause nausea, dizziness, fainting or death. If you start to feel dizzy or weak, get to fresh air immediately.

1. Set up generator outdoors, far away from building, windows, doors, vents or other openings.

2. Ground generator per instructions in the generator's operators manual.
3. Start generator.
4. Connect generator to PIB using included Champion Power Cord. The green light on the PIB outlet cover should be illuminated.
5. At the MTS, the blue light should be illuminated meaning there is generator power to the transfer switch. Push bottom of switch to transfer power from "UTILITY" to "GENERATOR".

All selected circuits are now powered by Generator.

Loading of the generator can be controlled by turning select circuit's circuit breakers on or off.

Transferring from Generator to Utility

1. At the MTS, the green light should be illuminated meaning there is Utility power to the transfer switch. Push top of switch to transfer power from "GENERATOR" to "UTILITY".

All selected circuits are now powered by Utility.

2. Turn generator off. Blue light on panel will turn off when no generator power.
3. Unplug power cord from generator and PIB. Store generator and cord.

DRAWING AND DIAGRAM

Dimensions Drawing

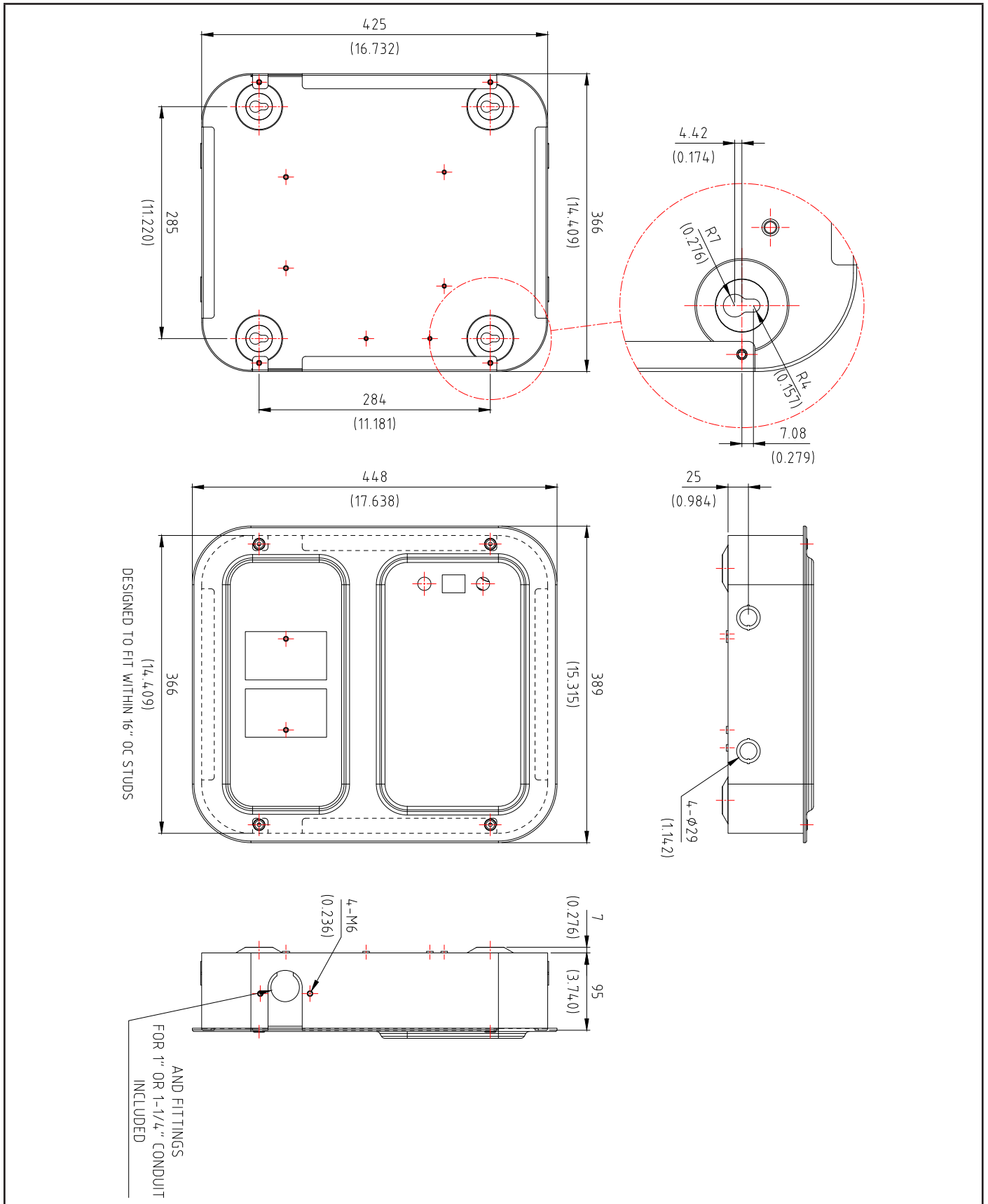

SPECIFICATIONS

Model	201193
Amperage (A)	50
Voltage (V)	240
Frequency (Hz)	60
Phase	1
Enclosure Rating	NEMA 1 (Indoor)
Circuits	10
Breakers Included	2-30A 2-pole 2-20A 1-pole 2-20A 1-pole tandem
Conduit Size	1 inch
ETL Listings	UL 1008 CSA C22.2 No. 178.1
Power Inlet Box Enclosure Rating	NEMA 3R
Power Inlet Box Receptacle	SS2-50P
Weight (lbs/kg)	48.1 / 21.8
Height (in/mm)	17.6 / 448
Width (in/mm)	15.3 / 389
Depth (in/mm)	4.4 / 112

Technical Specifications

- 500A short-time current rating.
- Suitable for use in accordance with Article 702 of National Electrical Code, NFPA 70.
- Suitable for CU and Al wire, 75 deg C minimum
- Continuous load not to exceed 100% of switch rating.
- Torque terminal connections to 40 in-lbs [Nm]

WARRANTY

Each Champion transfer switch is guaranteed against mechanical or electrical failure due to manufacturing defects for a period of **5-years** from date of purchase. Power Inlet Box and Power Cord are guaranteed for a period of 1-year from date of purchase. The manufacturer's responsibility during this warranty period is limited to repair or replacement, free of charge, of products proving defective under normal use or service when returned to the factory, transportation charges prepaid. Guarantee is void on products that have been subjected to improper installation, misuse, alteration, abuse or unauthorized repair. The manufacturer makes no warranty with respect to the fitness of any goods for a user's particular application and assumes no responsibility for proper selection and installation of its products. This warranty is in lieu of all other warranties, expressed or implied, and limits the manufacturer's liability for damages to the cost of the product. This warranty gives you specific legal rights, and you may have other rights, which vary from state to state.

WARRANTY*

CHAMPION POWER EQUIPMENT

TRANSFER SWITCH: 5-YEAR LIMITED WARRANTY

POWER INLET BOX: 1-YEAR LIMITED WARRANTY

POWER CORD: 1-YEAR LIMITED WARRANTY

Warranty Qualifications

To register your product for warranty and FREE lifetime call center technical support please visit:

<https://www.championpowerequipment.com/register>

To complete registration you will need to include a copy of the purchase receipt as proof of original purchase. Proof of purchase is required for warranty service. Please register within ten (10) days from date of purchase.

Repair/Replacement Warranty

CPE warrants to the original purchaser that the mechanical and electrical components will be free of defects in material and workmanship for a period of (5) years (parts and labor) from the original date of purchase and 180 days (parts and labor) for commercial and industrial use. Transportation charges on product submitted for repair or replacement under this warranty are the sole responsibility of the purchaser. This warranty only applies to the original purchaser and is not transferable.

Do Not Return The Unit To The Place Of Purchase

Contact CPE's Technical Service and CPE will troubleshoot any issue via phone or e-mail. If the problem is not corrected by this method, CPE will, at its option, authorize evaluation, repair or replacement of the defective part or component at a CPE Service Center. CPE will provide you with a case number for warranty service. Please keep it for future reference. Repairs or replacements without prior authorization, or at an unauthorized repair facility, will not be covered by this warranty.

Warranty Exclusions

This warranty does not cover the following repairs and equipment:

Normal Wear

Products with mechanical and electrical components need periodic parts and service to perform well. This warranty does not cover repair when normal use has exhausted the life of a part or the equipment as a whole.

Installation, Use and Maintenance

This warranty will not apply to parts and/or labor if the product is deemed to have been misused, neglected, involved in an accident, abused, loaded beyond the product's limits, modified, installed improperly or connected incorrectly to any electrical component. Normal maintenance is not covered by this warranty and is not required to be performed at a facility or by a person authorized by CPE.

Other Exclusions

This warranty excludes:

- Cosmetic defects such as paint, decals, etc.
- Circuit breakers
- Failures due to acts of God and other force majeure events beyond the manufacturer's control.
- Problems caused by parts that are not original Champion Power Equipment parts.

Limits of Implied Warranty and Consequential Damage

Champion Power Equipment disclaims any obligation to cover any loss of time, use of this product, freight, or any incidental or consequential claim by anyone from using this product. THIS WARRANTY IS IN LIEU OF ALL OTHER WARRANTIES, EXPRESS OR IMPLIED, INCLUDING WARRANTIES OF MERCHANTABILITY OR FITNESS FOR A PARTICULAR PURPOSE.

A unit provided as an exchange will be subject to the warranty of the original unit. The length of the warranty governing the exchanged unit will remain calculated by reference to the purchase date of the original unit.

This warranty gives you certain legal rights which may change from state to state or province to province. Your state or province may also have other rights you may be entitled to that are not listed within this warranty.

Contact Information

Address

Champion Power Equipment, Inc.
6370 S Pioneer Way, Unit 101
Las Vegas, NV 89113 USA
www.championpowerequipment.com

Customer Service

Toll Free: 1-877-338-0999
info@championpowerequipment.com
Fax no.: 1-562-236-9429

Technical Service

Toll Free: 1-877-338-0999
tech@championpowerequipment.com
24/7 Tech Support: 1-562-204-1188