



# OPERATOR'S MANUAL

## MODEL #13004

### 3,000 LB. WINCH



**ACTIVATE YOUR WARRANTY**

by registering your product:  
[championpowerequipment.com](http://championpowerequipment.com)

SERIAL NO.



**1-877-338-0999**

or visit [championpowerequipment.com](http://championpowerequipment.com)

**READ AND SAVE THIS MANUAL.** This manual contains important safety precautions which should be read and understood before operating the product. Failure to do so could result in serious injury. This manual should remain with the product.

Specifications, descriptions and illustrations in this manual are as accurate as known at the time of publication, but are subject to change without notice.

**TABLE OF CONTENTS**

<b>Introduction</b> .....	<b>3</b>	<b>Maintenance</b> .....	<b>13</b>
<b>Safety Definitions</b> .....	<b>3</b>	Lubrication .....	13
<b>Important Safety Instructions</b> .....	<b>4</b>	Steel Rope Replacement .....	13
Operation Symbols .....	5	Synthetic Rope Replacement (Optional) .....	13
<b>Controls and Features</b> .....	<b>6</b>	Synthetic Rope .....	13
Winch .....	6	<b>Specifications</b> .....	<b>14</b>
Assembly Parts .....	7	Performance Specifications .....	14
<b>Assembly</b> .....	<b>8</b>	<b>Troubleshooting</b> .....	<b>15</b>
Assembling the Winch .....	8		
Mounting the Remote control .....	8		
Winch Wiring .....	8		
Wiring Diagram .....	10		
<b>Operation</b> .....	<b>11</b>		
General Tips for Safe Operation .....	11		
Self Recovery .....	11		
Winching Techniques A-Z .....	12		

** FOR PARTS BREAKDOWN**

Search by model number at  
[championpowerequipment.com](http://championpowerequipment.com)

## INTRODUCTION

Congratulations on your purchase of a Champion Power Equipment (CPE) product. CPE designs, builds, and supports all of our products to strict specifications and guidelines. With proper product knowledge, safe use, and regular maintenance, this product should bring years of satisfying service.

Every effort has been made to ensure the accuracy and completeness of the information in this manual at the time of publication, and we reserve the right to change, alter and/or improve the product and this document at any time without prior notice.

Since CPE highly values how our products are designed, manufactured, operated and are serviced, and also highly value your safety and the safety of others, we would like you to take the time to review this product manual and other product materials thoroughly and be fully aware and knowledgeable of the assembly, operation, dangers and maintenance of the product before use. Fully familiarize yourself, and make sure others who plan on operating the product fully familiarize themselves too, with the proper safety and operation procedures before each use. Please always exercise common sense and always err on the side of caution when operating the product to ensure no accident, property damage, or injury occurs. We want you to continue to use and be satisfied with your CPE product for years to come.

When contacting CPE about parts and/or service, you will need to supply the complete model and serial numbers of your product. Transcribe the information found on your product's nameplate label to the table below

### CPE TECHNICAL SUPPORT TEAM

1-877-338-0999

### MODEL NUMBER

13004

### SERIAL NUMBER

### DATE OF PURCHASE

### PURCHASE LOCATION

## SAFETY DEFINITIONS

The purpose of safety symbols is to attract your attention to possible dangers. The safety symbols, and their explanations, deserve your careful attention and understanding. The safety warnings do not by themselves eliminate any danger. The instructions or warnings they give are not substitutes for proper accident prevention measures.

### DANGER

DANGER indicates a hazardous situation which, if not avoided, will result in death or serious injury.

### WARNING

WARNING indicates a hazardous situation which, if not avoided, could result in death or serious injury.

### CAUTION

CAUTION indicates a hazardous situation which, if not avoided, could result in minor or moderate injury.

### NOTICE

NOTICE indicates information considered important, but not hazard-related (e.g., messages relating to property damage or physical injury).

# IMPORTANT SAFETY INSTRUCTIONS

## **⚠ WARNING**

Cancer and Reproductive Harm –  
[www.P65Warnings.ca.gov](http://www.P65Warnings.ca.gov)

## **⚠ WARNING**

Do not exceed the rated capacity.

## **⚠ DANGER**

Do not use this winch for lifting or moving people or animals.

## **⚠ DANGER**

Keep yourself and others a safe distance to the side of the rope when under tension.

## **⚠ DANGER**

Never step over a rope or near a rope under load.

## **⚠ WARNING**

The rope may break before the motor stalls.  
For heavy loads at or near rated capacity, use a pulley block/snatch block to reduce the load on the rope.

## **⚠ WARNING**

Do not move the vehicle to pull a load (towing) on the winch rope. This could result in rope breakage.

## **⚠ WARNING**

Pull only on areas of the vehicle as specified by the vehicle manufacturer.

## **⚠ WARNING**

Do not use the winch to secure or hold a vehicle for a long period of time. Do not use the winch to secure a vehicle for transport.

## **⚠ WARNING**

Disconnect the remote control and battery leads when not in use.

## **⚠ WARNING**

Avoid “shock loads” by using the control switch intermittently to take up the slack in the rope. “Shock loads” can far exceed the rate capacity for the wire rope and drum.

Do not accelerate your vehicle while winching. Loss of traction can cause a shock load on the cable.

## **⚠ WARNING**

Batteries contain acid and produce explosive gases.

Keep sparks, flames and cigarettes away from batteries at all times. Wear safety glasses and protect the eyes at all times. Do not lean over the batteries during operation.

## **⚠ WARNING**

Do not use as a hoist. Do not use for overhead lifting.

## **⚠ WARNING**

When re-spooling the rope, ensure that the rope spools in the under-wind position with the rope entering the drum from the bottom, not the top.

To re-spool correctly, and while wearing gloves, keep a slight load on the rope while pushing the remote button to draw in the rope. Walk toward the winch not allowing the rope to slide through your hands. Do not let your hands get within 12 in. of the winch while re-spooling. Turn off the winch and repeat the procedure until a few feet of rope are left. Disconnect the remote control and finish spooling by rotating the drum by hand with the clutch disengaged. Keep hands clear of the fairlead and drum while the winch is under power .

## **⚠ CAUTION**

Use gloves to protect hands when handling the rope. Never let the rope slide through your hands.

**⚠ CAUTION**

Do not wrap the rope around any object and hook it back onto itself.

**⚠ CAUTION**

Apply blocks to the wheels of the vehicle when on an incline.

**⚠ CAUTION**

Duration of winching pulls should be kept as short as possible.

If the motor becomes uncomfortably hot to the touch, stop winching immediately and let it cool down for a few minutes. Do not pull for more than one minute at or near the rated load.

**⚠ CAUTION**

If the motor stalls, do not maintain power to the winch.

Electric winches are designed and made for intermittent use and should not be used in constant duty applications.

**⚠ CAUTION**

Never release the free-spool clutch when there is a load on the winch.

**⚠ CAUTION**







Use hook strap when handling the hook for spooling or unspooling the rope.

**⚠ CAUTION**

DO NOT mix old and new batteries  
DO NOT mix alkaline, standard, or rechargeable batteries.

**Operation Symbols**

Some of the following symbols may be used on this product. Please study them and learn their meaning. Proper interpretation of these symbols will allow you to more safely operate the product.

Symbol	Meaning
	Turn the clutch to the "IN" position to retract the rope.
	Turn the clutch to the "OUT" position to release the rope.
	Positive battery terminal
	Negative battery terminal
	Positive winch terminal
	Negative winch terminal

## CONTROLS AND FEATURES

Read this operator's manual before operating your winch. Familiarize yourself with the location and function of the controls and features. Save this manual for future reference.

### Winch

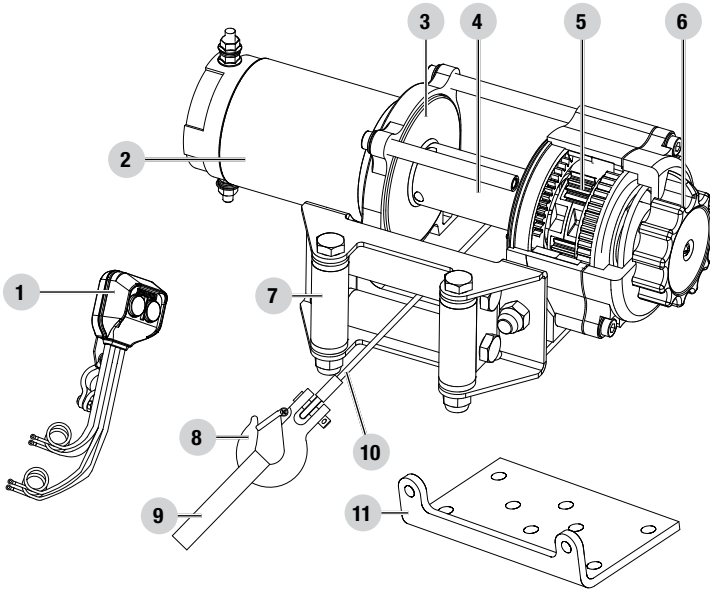

1. **Remote Control** – Rocker switch with handlebar mount for powering the rope in or out of your winch drum.
2. **Motor** – 1.3 HP 12V DC motor provides power to the planetary gear mechanism.
3. **Braking System** – Braking action is automatically applied to the winch drum when the winch motor is stopped and there is a load on the wire rope.
4. **Winch Drum** – The winch drum is the cylinder on which the wire rope is stored. It can feed or wind the rope depending on the remote winch switch.
5. **Planetary Gear System** – The reduction gears convert the winch motor power into extreme pulling forces. This system allows high torque while maintaining compact size and light weight.
6. **Free spooling Clutch** – The clutch allows the operator to manually disengage “Out” the spooling drum from the gear train, free spool. Engaging the clutch “In” locks the winch into the gear system.
7. **Roller Fairlead** – When using the winch at an angle the roller fairlead acts to guide the wire rope onto the drum and minimizes damage to the wire rope from abrasion on the winch mount or bumper.
8. **Clevis Hook** – Provides a means for connecting the looped ends of cables to an anchor.
9. **Strap** – Used to assist cable feed.
10. **Wire Rope** – 3/16 in. x 45.9 ft. galvanized aircraft cable designed specifically for load capacity of 3000 lb. (1361 kg).
11. **Mount Assembly** – Flatbed mounting channel.

## Assembly Parts

Part	Part Qty.	Hardware	Hardware Qty	Tools Needed
Roller Fairlead	1	Bolt M10 × 20	2	2× 16mm wrench or socket
		Washer Ø10	2	
		Lock washer Ø10	2	
		Lock nut M10	2	
Winch body	1	Bolt M8 × 25	4	1× 13mm wrench or socket
		Washer Ø8	4	
		Lock washer Ø8	4	
Clevis hook	1			Needle nose pliers
Yellow Strap	1			
Remote Control	1			

## ASSEMBLY

Your CPE 3000 lb. (1361 kg) winch is designed with a bolt pattern that is standard in this class of winch. Many winch mounting kits are available that utilize this bolt pattern for the most popular trucks and Sport Utility Vehicles/UTV's and ATV's. If you cannot find a kit locally, contact CPE and we will provide you with the name of a dealer near you.

### ⚠ CAUTION

Mounting bolts must be SAE grade 5 or better and torque to 34 ft. lb.

### ⚠ CAUTION

If utilizing a mounting plate, ensure that the three major sections (motor, drum, and gear housing) are properly aligned. Proper alignment of the winch will allow for even distribution of the full rated load.

### 🗨 NOTICE

The type of vehicle to which the winch and mounting plate will be applied, will dictate the type of mounting kit that should be used (Speed Mount™ hitch adapter, standard mounting plate, or specialty mounting kit).

## Assembling the Winch

1. Insert M10x20 bolts through the mounting channel holes and attach the roller fairlead to the mounting channel with the M10 lock washers and M10 nuts provided.

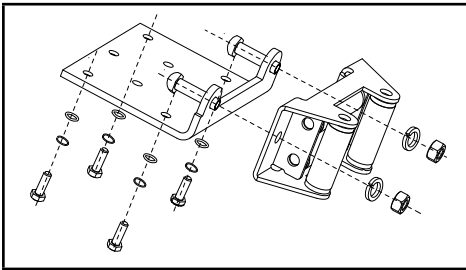

2. Turn the winch upside down. Place the mounting channel on the winch, making sure the winch is centered in the middle of it.

3. Thread the M8x25 bolts through the M8 flat and lockers washers, and then thread through the mounting channel. Tighten the bolts. DO NOT over tighten.
4. Turn winch right side up. Disengage the clutch by moving the Cam Ring to the "Out" position. Release the wire rope and pull through the roller fairlead.
5. Attach the clevis hook to the cable, and then hand strap to the clevis hook.

## Mounting the Remote control

1. The remote control is usually installed on the left handlebar.
2. Use a piece of electrical tape around the handlebar to help prevent rotation of the mount on the handlebar. Do NOT tighten over any hoses or cables.
3. Once the remote control is mounted you can route the wires back to the battery and winch.
4. Make sure the handlebars have full range of motion and then secure the remote control's cable.

## Winch Wiring

### ⚠ CAUTION

Never route electrical cables across any sharp edges, through or near moving parts, or near parts that become hot.

1. Mount the winch to your vehicle.
2. FOR WINCH TO FULLY FUNCTION CONNECT ALL LEADS CORRECTLY.
3. Connect the battery leads: Connect the red (+) lead to the positive (+) terminal of the vehicle's 12 volt battery. Connect the black (-) lead to the negative (-) terminal of the vehicle's 12 volt battery. (see wiring diagram)
4. Connect the winch leads: Connect red (+) lead of the winch connection cables to the positive (+) terminal of the winch motor. Connect the black (-) lead of the winch connection cables to the negative (-) terminal of the winch motor. (see wiring diagram)

5. Check for proper drum rotation. Pull and turn the clutch knob to the “out” position (Free spooling). Pull out some cable from the drum, and then turn the clutch knob to the “In” position to engage the gears. Press the cable out button on the handlebar switch. If the drum is turning and releasing more cable then your connections are accurate. If the drum is turning and collecting more cable then reverse the leads on the motor. Repeat and check rotation.

**⚠ CAUTION**

Battery cables should not be drawn taut. Leave some slack for cable movement.

With some applications the motor leads may need to be rotated to avoid interference with other components.

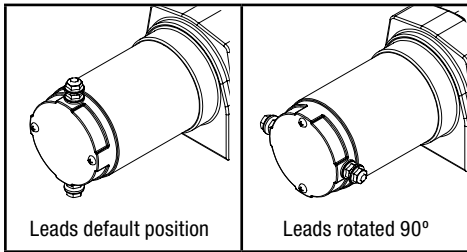

# Wiring Diagram

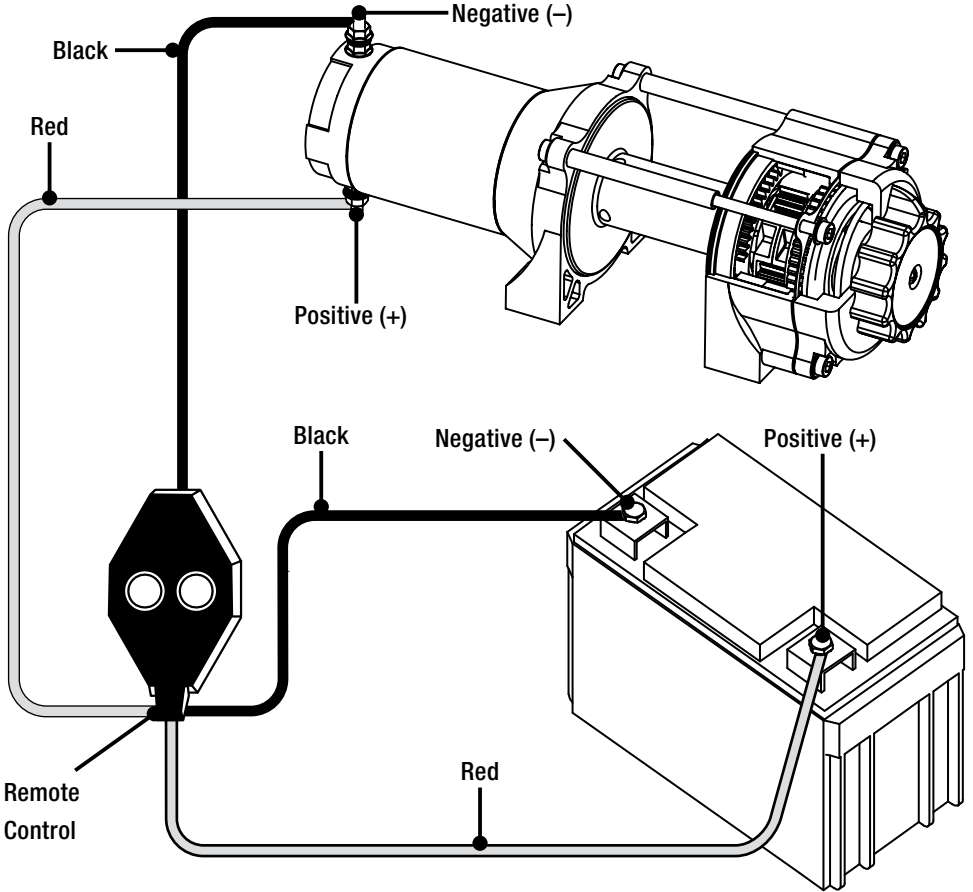

## OPERATION

### General Tips for Safe Operation

Your winch is rated at a 3000 lb. (1361 kg) capacity in first layer (max) when spooling the first rope layer on the drum. Overloads can damage the winch, motor and/or wire rope. For loads over 50% we recommend the use of the pulley block/snatch block (not included) to double the wire rope line. This will aid in two ways:

- reduce the number of rope layers on the drum, as well as,
- reduce the load on the wire rope by as much as 50%.

When doubling the line back to the vehicle, attach to the tow hook, frame or other load bearing part. The vehicle engine should be kept running during operation of the winch to minimize battery drain and maximize power and speed of the winch. If the winch is used for a considerable time with the engine off the battery may be drained and too weak to restart the engine.

Get to know your winch before you actually need to use it. We recommend that you set up a few test runs to familiarize yourself with rigging techniques, the sounds your winch makes under various loads, the way the cable spools on the drum, etc.

Inspect the wire rope and equipment before each use. A frayed or damaged rope shall be replaced immediately. Use only manufacturer's identical replacement rope with the exact specifications.

Inspect the winch installation and bolts to ensure that all bolts are tight before each operation. Store the remote control inside your vehicle in a place that it will not be damaged.

Any winch that appears to be damaged in any way, is found to be worn, or operates abnormally **MUST BE REMOVED FROM SERVICE UNTIL REPAIRED**. It is recommended that the necessary repairs be made by a manufacturer's authorized repair facility.

Pull only on areas of the vehicle as specified by the vehicle manufacturer. Only attachments and/or adapters supplied by the manufacturer are to be used.

### Self Recovery

Locate a suitable anchor such as a strong tree trunk or boulder. Always use a sling (not included) as an anchor point.

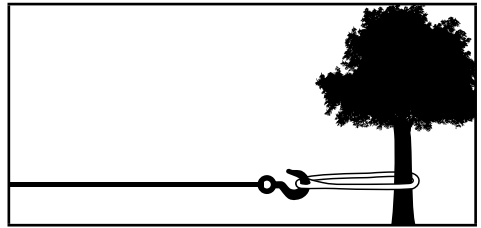

A roller fairlead (included) will help guide the wire rope and to reduce binding on short side pulls. Do not winch from an acute angle as the wire rope will pile up on one side of the drum causing damage to wire rope and the winch.

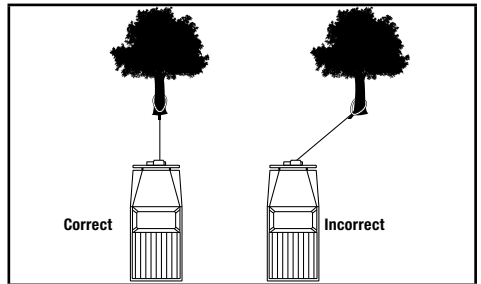

Short pulls from an angle can be used to straighten the vehicle. Long pulls should be done with the wire rope at a 90° angle to the winch/vehicle. When pulling a heavy load, place a blanket or jacket over the wire rope 5-6 ft. (1.5-1.8 m) from the hook.

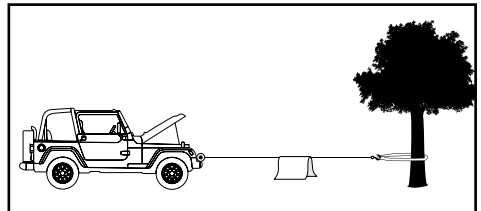

In the event of a broken cable it will dampen the snap back. For additional protection open the hood of the vehicle. For pulls over 50%, we recommend the use of the snatch block/pulley block to double line the wire rope.

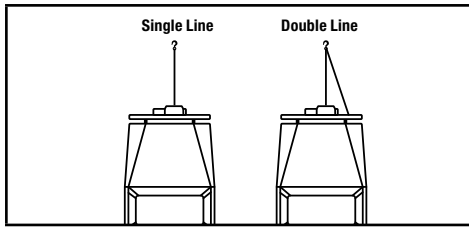

This reduces the load on the winch and the strain on the rope by approximately 50%.

## Winching Techniques A-Z

- A. Take time to assess your situation and plan your pull.
- B. Put on gloves to protect your hands.
- C. Disengage the clutch to allow free-spooling and also save battery power.
- D. Attach the hook strap to the clevis hook.
- E. Pull out the wire rope to your desired anchor point using the hook strap.
- F. Secure the clevis hook to the anchor point: Sling, chain or snatch block. Do not attach the hook back onto the wire rope.
- G. Engage the clutch.
- H. Connect the remote control to the winch. If you are going to control the winch from inside your vehicle then pass the remote through an open window to avoid the wires being pinched in the door.
- I. Start your engine to ensure power is being replenished to the battery.
- J. Power in the wire rope guiding the wire under tension to draw up the slack in the wire. Once the wire is under tension, stand clear. Never step over the wire rope.
- K. Double check your anchors and make sure all connections are secure.
- L. Inspect the wire rope. Make sure there are at least 5 wraps of wire rope around the winch drum.
- M. Drape a blanket or jacket over the wire rope approximately 5-6 ft. (1.5-1.8 m) from the hook. Open the hood for added protection.
- N. Clear the area. Make sure all spectators stand clear and that no one is directly in front or behind the vehicle or anchor point.
- O. Begin winching. Be sure that the wire rope is winding evenly and tightly around the drum. The vehicle that is being winched can be slowly driven to add assistance to the winching process. Avoid shock loads; keep the wire rope under tension.
- P. The vehicle to be winched should be placed in neutral and the emergency brake released. Only release the brake pedal when under full tension. Avoid shock loads to the winch. This can damage the winch, rope and vehicle.
- Q. The winch is meant for intermittent use. Under full load with a single line rig do not power in for more than a minute without letting the motor cool down for a few minutes and then resume the winching operation.
- R. The winching operation is complete once the vehicle is on stable ground and is able to drive under its own power.
- S. Secure the vehicle. Be sure to set the brakes and place the vehicle in park.
- T. Release the tension on the wire rope. The winch is not meant to hold the vehicle for long periods of time.
- U. Disconnect the wire rope from the anchor.
- V. Rewind the wire rope. Make sure that any wire already on the drum has spooled tightly and neatly. If not, draw out the wire and re-spool from the point where the rope is tight.
- W. Keep your hands clear of the winch drum and fairlead as the wire rope is being drawn in.
- X. Secure the hook and hook strap.
- Y. Disconnect the remote control and store in a clean, dry place.
- Z. Clean and inspect connections and mounting hardware for next winching operation.

## MAINTENANCE

The owner/operator is responsible for all periodic maintenance.

Complete all scheduled maintenance in a timely manner. Correct any issue before operating the winch.

### WARNING

Never operate a damaged or defective winch.

### WARNING

Improper maintenance will void your warranty.

### NOTICE

For service or parts assistance, contact our help line at 1-877-338-0999.

## Lubrication

All moving parts within the electric winch have been lubricated using high-temperature lithium grease at the factory. No internal lubrication is required.

## Steel Rope Replacement

It is recommended that any modifications be performed by a manufacturer's authorized repair facility, and that only manufacturer-supplied parts be used.

1. Move the clutch to the "Out" position.
2. Extend wire rope to its full length. Note how the existing rope is connected to the inside of the drum.
3. Remove old wire rope and attach new one.
4. Retract wire rope onto drum, being careful not to allow kinking.

## Synthetic Rope Replacement (Optional)

It is recommended that any modifications be performed by a manufacturer's authorized repair facility, and that only manufacturer-supplied parts be used.

1. Move the clutch to the "Out" position.
2. Extend synthetic rope to its full length. Note how the existing rope is connected to the inside of the drum.
3. Remove old synthetic rope and attach new one.
4. Retract synthetic rope onto drum being careful not to allow kinking.

## Synthetic Rope

Periodically rinse the synthetic rope with water to remove any sand, dirt, mud, or debris that can become embedded or build up in the rope during use. This will help extend the life of the rope.

### NOTICE

Inspect rope before and after each use. If rope becomes frayed it must be replaced.

# SPECIFICATIONS

## Performance Specifications

Rated Pull .....	3000 lb. (1361 kg)	Mounting Bolt Pattern .....	4.9 in. × 3 in. (12.4 cm × 7.6 cm)
Gear Reduction Ratio .....	171:1	Overall Dimensions .....	12.7 in. (L) × 4.1 in. (W) × 4.2 in. (H) 32.2 cm × 10.3 cm × 10.7 cm
Motor .....	Permanent magnet 1.3 HP/1.0 kW (DC 12V)		
Drum Size .....	1.5 in. × 3.15 in. (38 mm × 80 mm)		
Rope Dimensions .....	3/16 in. × 45.9 ft. (4.8 mm × 14 m)		
Gross Weight .....	22.7 lb. (10.3 kg)		
Net Weight .....	19.8 lb. (9 kg)		

### Line Speed and Motor Current (First Layer)

Line Pull	LB	0	1000	2000	3000
	KG	0	454	907	1361
Line Speed (12V DC)	FPM	8.86	7.55	5.25	4.27
	MPM	2.7	2.3	1.6	1.3
Max Current	A	15	60	120	170
Run Time*	Minutes	1	1	1	1
Cooling Time**	Minutes	5	5	5	5

\* If the motor becomes uncomfortably hot to the touch, stop winching immediately and let it cool down for 5 minutes. Do not pull for more than one minute at or near the rated load.

\*\*Electric winches are designed and made for intermittent use and should not be used in constant duty applications.

### Line Pull and Cable Capacity Per Layer

Line of Cable		1	2	3	4	5
Rated Line Pull	LB	3000	2450	2070	1793	1581
	KG	1361	1112	940	814	718
Cable Capacity	FT	7.15	15.45	24.7	34.5	45.9
	M	2.18	4.71	7.52	11.5	14

– Use double line and snatch block for pulling loads over 50%.

# TROUBLESHOOTING

Problem	Cause	Solution
Motor does not turn on.	Switch assembly not connected properly.	Insert switch assembly all the way into the connector.
	Loose battery cable connections.	Tighten nuts on all cable connections.
	Contactors malfunctioning.	Tap contactor to loosen contacts. Apply 12 volts to coil terminals directly. A clicking indicates proper activation.
	Defective switch assembly.	Replace switch assembly.
	Defective motor.	Check for voltage at armature port with switch pressed. If voltage is present, replace motor.
	Water has entered motor.	Allow to drain and dry. Run in short burst with load until completely dry.
Motor runs but cable drum does not turn.	Clutch (cam ring) not engaged.	Move cam ring to the "In" position. If problem persists, a qualified technician needs to check and repair.
Motor runs slowly or without normal power.	Insufficient current or voltage.	The battery is weak, recharge. Run winch with vehicle motor running (battery should have a strong charge).
	Loose or corroded battery cable connections.	Clean, tighten, or replace.
Motor overheating.	Winch running time too long.	Allow winch to cool down periodically.
Motor runs in one direction only.	Defective or stuck contactor.	Tap contactor to loosen contacts.
		Repair or replace contactor.
	Defective switch assembly.	Replace switch assembly.

### For further technical support:

Technical Support Team

Toll Free 1-877-338-0999

support@championpowerequipment.com

# WARRANTY\*

CHAMPION POWER EQUIPMENT  
2 YEAR LIMITED WARRANTY

## Warranty Qualifications

To register your product for warranty and FREE lifetime call center technical support please visit:

<https://www.championpowerequipment.com/register>

To complete registration you will need to include a copy of the purchase receipt as proof of original purchase. Proof of purchase is required for warranty service. Please register within ten (10) days from date of purchase.

## Repair/Replacement Warranty

CPE warrants to the original purchaser that the mechanical and electrical components will be free of defects in material and workmanship for a period of two years (parts and labor) from the original date of purchase and 180 days (parts and labor) for commercial and industrial use. Transportation charges on product submitted for repair or replacement under this warranty are the sole responsibility of the purchaser. This warranty only applies to the original purchaser and is not transferable.

## Do Not Return The Unit To The Place Of Purchase

Contact CPE's Technical Service and CPE will troubleshoot any issue via phone or e-mail. If the problem is not corrected by this method, CPE may, at its option, authorize other means of repair and/or replacement.

## Warranty Exclusions

This warranty does not cover the following repairs and equipment:

### Normal Wear

Products with mechanical and electrical components need periodic parts and service to perform well. This warranty does not cover repair when normal use has exhausted the life of a part or the equipment as a whole.

### Installation, Use and Maintenance

This warranty will not apply to parts and/or labor if the product is deemed to have been misused, neglected, involved in an accident, abused, loaded beyond the product's limits, modified, installed improperly or connected incorrectly to any electrical component. Normal maintenance is not covered by this warranty and is not required to be performed at a facility or by a person authorized by CPE.

## Other Exclusions

This warranty excludes:

- Cosmetic defects such as paint, decals, etc.
- Wear items such as winch cable, etc.
- Accessory parts such as storage covers.
- Failures due to acts of God and other force majeure events beyond the manufacturer's control.
- Problems caused by parts that are not original Champion Power Equipment parts.

## Limits of Implied Warranty and Consequential Damage

Champion Power Equipment disclaims any obligation to cover any loss of time, use of this product, freight, or any incidental or consequential claim by anyone from using this product. THIS WARRANTY IS IN LIEU OF ALL OTHER WARRANTIES, EXPRESS OR IMPLIED, INCLUDING WARRANTIES OF MERCHANTABILITY OR FITNESS FOR A PARTICULAR PURPOSE.

A unit provided as an exchange will be subject to the warranty of the original unit. The length of the warranty governing the exchanged unit will remain calculated by reference to the purchase date of the original unit.

This warranty gives you certain legal rights which may change from state to state or province to province. Your state or province may also have other rights you may be entitled to that are not listed within this warranty.

## Contact Information

### Address

Champion Power Equipment, Inc.  
6370 S Pioneer Way, Unit 101  
Las Vegas, NV 89113 USA  
[www.championpowerequipment.com](http://www.championpowerequipment.com)

### Customer Service

Toll Free: 1-877-338-0999  
[info@championpowerequipment.com](mailto:info@championpowerequipment.com)  
Fax no.: 1-562-236-9429

### Technical Service

Toll Free: 1-877-338-0999  
[tech@championpowerequipment.com](mailto:tech@championpowerequipment.com)

📞 EMERGENCY 24 HOUR SUPPORT: 1-562-204-1188